



Gaither[®]
PROFESSIONAL EQUIPMENT

**REACHING
FOR NEW
HEIGHTS!**



INSTRUCTIONS FOR
GT3532-AG



WARNINGS

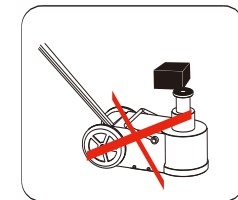
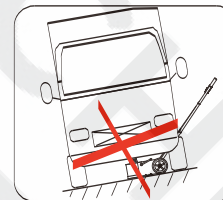
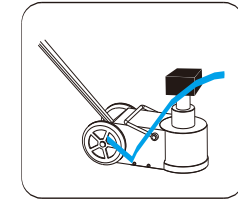
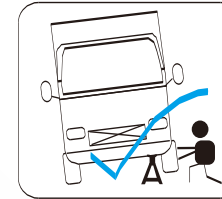
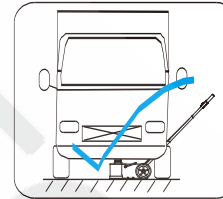
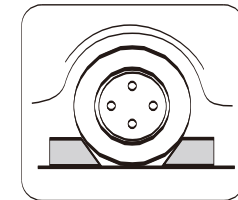
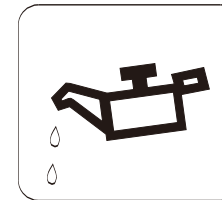

Technical Data

Item No. ; GT3532AG

Capacity:35T

Working air pressure:8-12Bar/120-175PSI

Min Height:360mm

Lifting Height:267mm

Max height:772mm

Extension:100mm+45mm

Warranty terms (with a minimum of 12 months), service availability, and service response times may vary from country or region to country or region.



Assembly

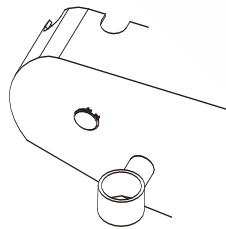
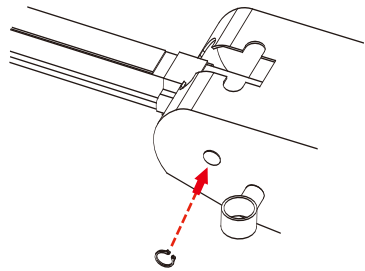
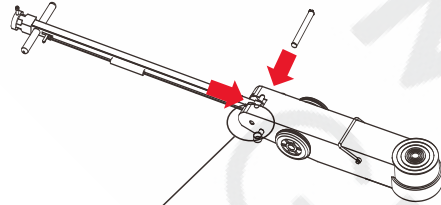
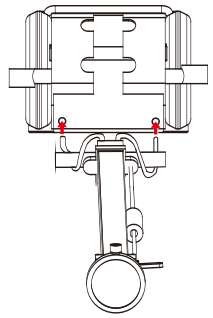
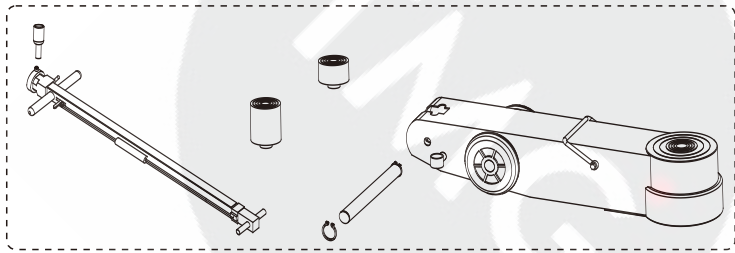

Usage

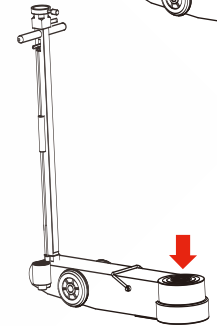
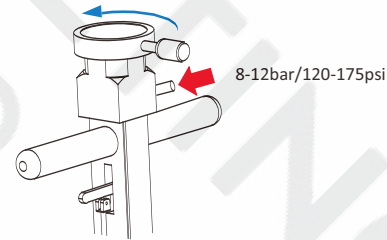
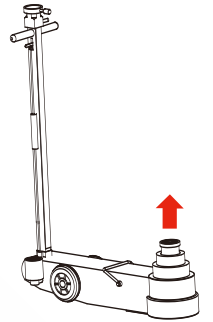
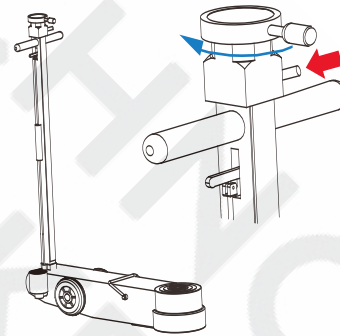
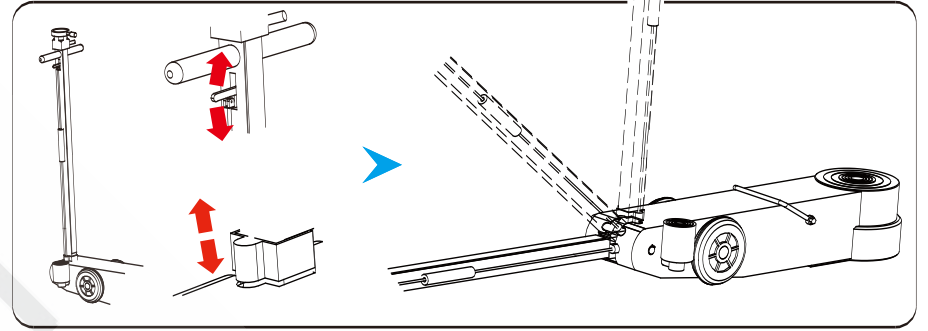

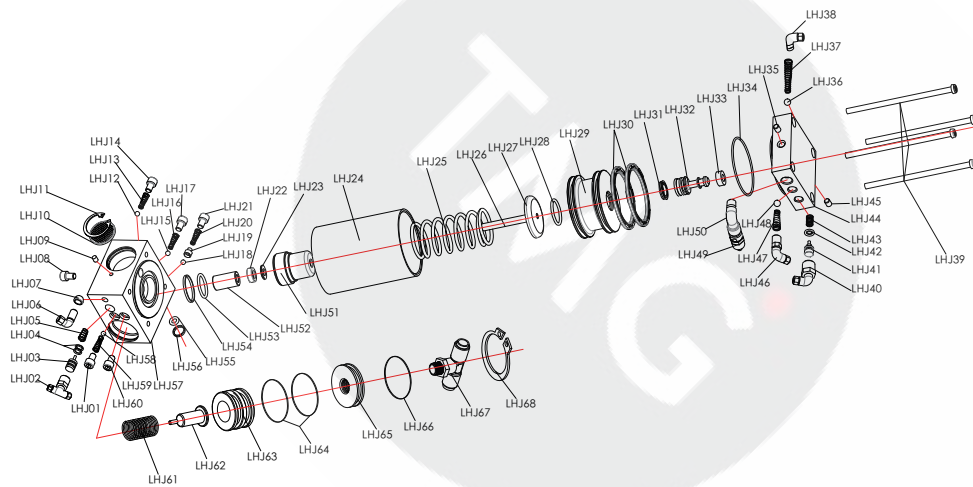

NO.:	Description
LHJ01	screw nut
LHJ02	tie in
LHJ03	piston
LHJ04	O ring
LHJ05	spring
LHJ06	tie in
LHJ07	fitter
LHJ08	screw nut
LHJ09	screw
LHJ10	silencer
LHJ11	clamp
LHJ12	steel ball
LHJ13	spring
LHJ14	screw nut
LHJ15	steel ball
LHJ16	spring
LHJ17	screw nut
LHJ18	steel ball
LHJ19	screw nut
LHJ20	spring
LHJ21	screw nut
LHJ22	B3 sealing
LHJ23	locking ring

NO.:	Description
LHJ24	air cylinder
LHJ25	spring
LHJ26	pluger rod
LHJ27	pluger cover
LHJ28	O ring
LHJ29	piston
LHJ30	PK sealing
LHJ31	Z8 sealing
LHJ32	piston
LHJ33	rubber cap
LHJ34	O ring
LHJ35	screw nut
LHJ36	steel ball
LHJ37	spring
LHJ38	tie in
LHJ39	screw
LHJ40	tie in
LHJ41	piston
LHJ42	O ring
LHJ43	spring
LHJ44	air inlet valve
LHJ45	screw nut
LHJ46	tie in

NO.:	Description
LHJ47	spring
LHJ48	steel ball
LHJ49	safe valve
LHJ50	tie in
LHJ51	oil pump
LHJ52	pluger bushing
LHJ53	O ring
LHJ54	O ring
LHJ55	O ring
LHJ56	locking ring
LHJ57	check valve
LHJ58	steel ball
LHJ59	spring
LHJ60	screw nut
LHJ61	spring
LHJ62	oil drain bolt
LHJ63	oil drain piston
LHJ64	O ring
LHJ65	end cover
LHJ66	O ring
LHJ67	tie in
LHJ68	clamp

F
DECLARATION OF CONFORMITÉ
Nous, **Gaither Europe BV**
Adresse : Rechtzaad 6
4703 RC Roosendaal – The Netherlands
déclarons sous notre seuce responsabilité que les
produits auxquels se réfère cette déclaration sont
conformes aux dispositions des Directives :
2006/42/CE, EN 1494

NL
VERKLARING VAN OVEREENKOMST
Wij, **Gaither Europe BV**
Adres: Rechtzaad 6
4703 RC Roosendaal – The Netherlands
verklaren geheel onder eigen verantwoordelijk-
heid dat de volgende producten, waarop deze
verklaring betrekking heeft, in overeenstem-
ming zijn met de bepalingen van Richtlijn:
2006/42/CE, EN 1494

I
DICHIARAZIONE DI CONFORMITÀ
Noi, **Gaither Europe BV**
Indirizzo: Rechtzaad 6
4703 RC Roosendaal – The Netherlands
dichiariamo sotto la nostra esclusiva responsabi-
lità che i prodotti ai quali questa dichiarazione
si riferisce sono conformi a quanto previsto dalle
direttive: 2006/42/CE, EN 1494

E
DECLARACIÓN DE CONFORMIDAD
Gaither Europe BV
Dirección: Rechtzaad 6
4703 RC Roosendaal – The Netherlands
declaramos bajo nuestra exclusiva responsabilidad
la conformidad de los productos a los que refiere
esta declaración, con las disposiciones de Directiva :
2006/42/CE, EN 1494

P
DECLARAÇÃO DE CONFORMIDADE
Nós, **Gaither Europe BV**
Endereço: Rechtzaad 6
4703 RC Roosendaal – The Netherlands
declaramos, sob nossa única responsabilidade,
que os seguintes produtos, incluídos nesta decla-
ração estão em conformidade com o disposto na
Directiva : 2006/42/CE, EN 1494

SE
FÖRSÄKRAN OM ÖVERESSTÄMMELSE
Vi, **Gaither Europe BV**
Adress: Rechtzaad 6
4703 RC Roosendaal – The Netherlands
försäkrar under eget ansvar att följande produkter
som omfattas av denna försäkran är i överens-
stämmelse med villkoren i direktiv:
2006/42/CE, EN 1494

N
ERKLÆRING OM OVERENSSTEMMELSE
Vi, **Gaither Europe BV**
Adresse : Rechtzaad 6
4703 RC Roosendaal – The Netherlands
erklærer på eget ansvar, at følgende produkter
som dækkes af denne erklæring, er i overens-
stemmelse med bestemmelserne i Direktiv :
2006/42/CE, EN 1494

DK
ÖVERENSSTEMMELSESERKLÆRING
Vi, **Gaither Europe BV**
Adresse: Rechtzaad 6
4703 RC Roosendaal – The Netherlands
erklærer på eget ansvar et følgende produkter
som er omfattet af denne erklæring, er i overens-
stemmelse med bestemmelserne i Direktiv:
2006/42/CE, EN 1494

FIN
VAATIMUSTENMUKAISUUSVAKUUTUS
Me, **Gaither Europe BV**
osoite: Rechtzaad 6
4703 RC Roosendaal – The Netherlands
vakuutamme yksinomaan omalia vastuullamme,
että seuraavat tuotteet, joihin tämä vakuutus liittyy,
ovat seuraavien direktiivien vaatimusten mukaisia :
2006/42/CE, EN 1494

GB
DECLARATION OF CONFORMITY
We, **Gaither Europe BV**
Address: Rechtzaad 6
4703 RC Roosendaal – The Netherlands
declare under our sole responsibility that the
following products to which this declaration
relates conform with the provisions of Directives :
2006/42/CE, EN 1494

D
Wir, **Gaither Europe BV**
Anschrift : Rechtzaad 6
4703 RC Roosendaal – The Netherlands
erklären auf eigene Verantwortung, daß folgende
Produkte, auf die sich diese Erklärung bezieht,
mit den Bedingungen der Direktiven 2006/42/CE
EN 1494 übereinstimmen.



Typ,tyyppi,type,type,Typ,type,tipo,type,tipo,tipo
GT3532AG

Rd
Ralph Dubbeddam
Managing Director
Gaither Europe BV
Date: 2015-11-01

GAITHER

NOTES



SMART
TECHNO
GROUP
MARKETING

ABOUT US

Gaither Tool Company, Inc. founded in 1988, is an international organization committed to serving the tire and trucking industry. It invents and manufactures convenient tools and systems needed to service and maintain tires and wheel assemblies.

Gaither Tool Company, Inc. continually invests in research and development to bring to its customers the most effective tools in the business. It strives to improve efficiency and reduce costs for customers all over the world working in truck maintenance shops as well as on-the-road tire service providers. Bandag, Euromaster/Michelin, Bridgestone's First Stop, The United States Armed Forces... just to name a few.

Gaither supplies products to customers in over 100 countries, selling through exclusive and nonexclusive distributors. Gaither Tool Company, Inc. is headquartered in Jacksonville, Illinois, U.S.A. In 1997 it opened a branch office located in Roosendaal, Holland to better serve the European market. In 1999 that office was incorporated in Holland and Gaither Europe BV was started. Gaither's manufacturing plant and warehousing for International distribution is located in Taichung, Taiwan.

With a strategically placed location in both The United States and The Netherlands, we are able to serve the global industry



CONTACT US

gaithereurope.com

GAITHER EUROPE BV

Rechtzaad 6
4703 RC Roosendaal (Holland)

† +31 (0) 165 554475

f +31 (0) 165 391819

e evd@gaithereurope.com



CHANGING THE WAY THE WORLD CHANGES TIRES